



H3 series IP Camera user Manual



Foreword

This series product is specific on network video surveillance including wired box ip camera, wireless box ip camera, wired dome ip camera wired IR waterproof ip camera, etc. It uses processor with high-performance chips to realize audio/video capture, compression, transmission, and the standard Motion-JPEG coding algorithm can confirm the clear-fluent effect of video transmission. It supports user to view real-time video and remote control via browser such as IE, super client software and APP platform.

These series of IP camera can be used for remotely monitoring places such as enterprises chain stores ,factories and home ,etc . it is easy to install to operate .Please check the items ,if there's any missing things , please contact the seller immediately.

Please check if the accessories are all in before installation. If there is any missing, please contact seller timely.

List of items:

- IP camera -----1 pc
- Bracket (refer to model) ----- 1 pc
- Power adapter ----- 1 pc
- Certificate----- 1 pc
- CD----- 1 pc
- Warranty card-----1 pc

Instruction:

IP Camera it is network camera; PC it is computer; single click: left click of mouse; double click: double left click of mouse.

IP Camera default administrator user name: admin, password: admin

Default LAN(local area network)IP address: 192.168.1.126, port: 81

Statement:

The device's version in the manual may be different from the current device's version, if you shouldn't use "u" here for the formal documentation ,should use "you" the installation can not finish referring to the manual, please contact seller.

The will be updated manufacture preserves authority of content update from time to time.



Forword	- 1 -
2 Features	- 3 -
3 Appearance and interface	- 5 -
3.1 Device appearance	- 5 -
3.2 Device interface	- 5 -
4 Network connection	- 6 -
4.1 Connection instruction	- 6 -
4.2 Access instruction	- 6 -
4.3 Connect network via ADSL	- 7 -
4.4 Access network through router.....	- 7 -
5. Software operating	- 7 -
5.1 IPcamera tool	- 8 -
5.2 Login device.....	- 9 -
5.3 Operations	- 10 -
5.4 Basic network configuration	- 11 -
5.5 DDNS configuration	- 12 -
5.6 E-mail service configuration.....	- 13 -
6 Central Management	- 13 -
6.1 Installation.....	- 13 -
6.2 Installation steps.....	- 14 -
6.3 Login and Logout.....	- 14 -
6.4 Software interface	- 15 -
6.5 Device management.....	- 17 -
6.6 Image preview.....	- 19 -
6.7 PTZ control	- 22 -
6.8 Video management.....	- 24 -
6.9 Playback.....	- 27 -
6.10 Electron map	- 29 -
6.12 User management.....	- 34 -
6.13 Log	- 34 -
6.14 Other settings	- 35 -
7 Port forwarding	- 36 -
8 Appendix	- 36 -
8.1 Common issue.....	- 36 -
8.2 Warranty instruction	- 37 -
8.3 Warranty card.....	- 38 -

1 Product Overview

IP Camera is designed as web server running on network, it can transmit real-time video to anywhere through internet, and user can view real-time live video via web browser any time. It is available to large stores, schools, factories, houses, etc.

Basic function: IPCAM can transmit real-time live video data to remote place through internet with hardware compression method MJPE which providing high-quality video image and 25fps frame rate on LAN/WAN (local area network/wide area network).

The IPCAM video data transmission is based on TCP/IP protocol, built-in web server supporting Internet Explore, thus, it make more easy to manage and maintain the devices to remotely configure, start and upgrade firmware, etc.



Please check if the items are all in before installation of IP camera, if there is some missing, please contact seller

2 Features

- powerful high speed video protocol processor
- high sensitive and high definition CMOS sensor
- 0.3 megapixels resolution
- IR night vision
- Optimized Motion-JPEG video compression algorithm, realize to transmit high definition image through narrow bandwidth
- multiuser management and password
- support browser (IE browser, Firefox browser, Google browser, etc)
- support wireless network(WiFi/802.11/b/g)
- support dynamic DNS (DDNS)
- support max size 32G SD card, snapshot and record on alarm
- motion detection
- support two-way audio
- image snapshot
- support mobile phone view
- log



- support network protocols: HTTP/TCP/IP/UDP/STMP/DDNS/SNTP/DHCP/FTP

System feature	security	Three-level account, password and user authority management
	Built-in ddns (free)	Built-in unique lifelong free DDNS, no need Oray, no worry about frequent offline and good speed. Such as http://demo.ipcam.hk, the series number is "demo"
	Mobile phone platform (free)	No need to install software, IE multi-view and management, snapshot alarm picture, etc
	Superiority	Support computer monitoring, support most smart phone such as Iphone, android, Symbian.
	Mobile phone view	Support Iphone、Windows Mobile、Symbian、Android directly viewing
	Local memory	Support 32G SD card local memory to alarm snapshot and record
Core	OS	Embedded Linux OS
	Processor	32Bit RSIC Embedded Processor
Video	Compression	H.264 main profile level 3, main stream and second stream
	Signal system	CMOS 0.3 megapixels
	Frame rate	Main stream: 1~25 fps, second stream: 1-25 fps
	Resolution	VGA(640*480),QVGA(320*240) QQVGA (160*120)
	Image adjustment	Brightness, contrast, adjustable
	BLC	AUTO
Network	Interface	RJ-45 10/100Mb self-adaptable Ethernet slot
	Protocol	Support TCP/IP、HTTP、ICMP、DHCP、FTP、SMTP、PPPoE, etc
	Wifi	WIFI,802.11 b/g/n
	Online user	Support 10 users directly access at the same time
	Support IP	Static ip, dynamic IP, PPPOE
	Input/output	One channel linear/Mic input, one channel audio output
Alarm	Alarm detect	Motion detection, sensitivity configuration
	Alarm linkage	Support Email, FTP upload image, call preset position, GPIO control, etc.
Certification	Certificate	ISO FCC CE SASO RoHS

3 Appearance and interface

3.1 Device appearance



Picture 1- device appearance

3.2 Device interface

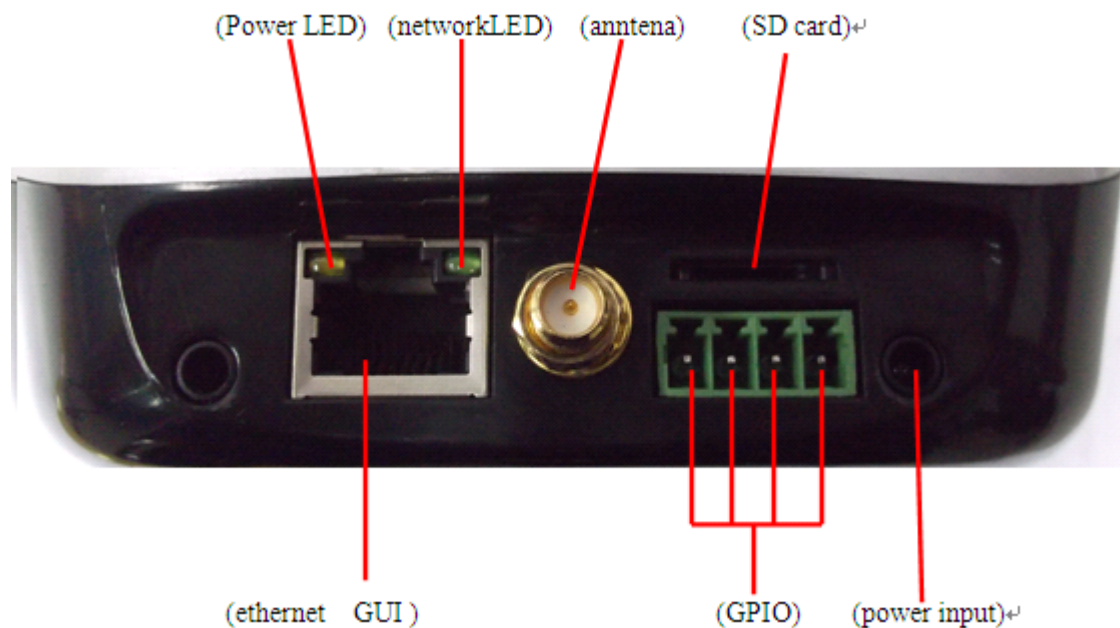

Picture 2- device interface

power: external power adapter DC 5V/2A

Ethernet interface: 10/100M self-adaptable Ethernet interface, can connect to many network devices, such as hub, router, switch, etc.

Network light: flickering when network connecting

Power light: always on when power on

SD card: support 32G SD card

I/O interface: one channel alarm input with 3, 4 pins (input grounded, low electric level trigger); TTL control for output with 1, 2 pins (1, 2 short-circuit) .

4 Network connection

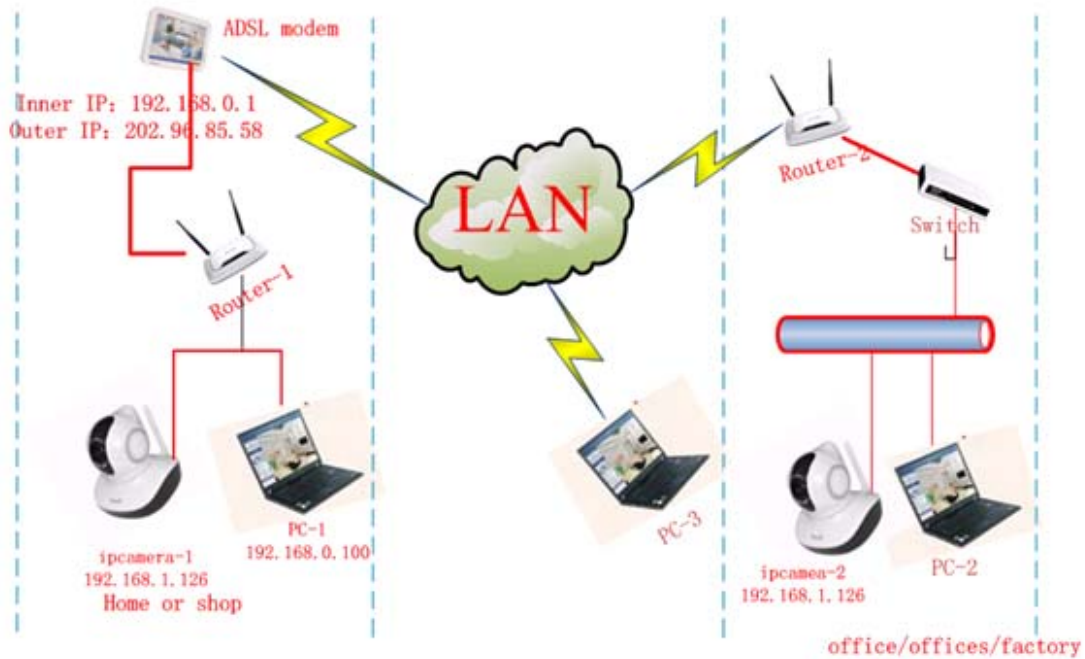

Picture 3- network connection guide

4.1 Connection instruction

Connect camera to router and connect power adapter before accessing IP Camera, and check the network light and power light if it is normal, confirm the cable status is good. To connection mode in picture 3:

- 1) camera-1 and camera-2 separately connect to two different LANS
- 2) the two LANS must directly connect to internet, and there is router in the LAN, the connection mode can be ADSL or optical fiber, etc.
- 3) computer-3 can access internet

4.2 Access instruction

For accessing camera, it should configure some simple settings on the cable in good status:

- 1) **computer and camera should be in the same subnet**

To access camera via inner access link(ip link), it should confirm the computer to be in the same subnet with the camera, otherwise it needs to configure the IP for IP Camera, for example: camera-1 in picture5 has IP 192.168.1.126 (it is in subnet 192.168.1), PC-1's IP is 192.168.0.100(it is in subnet 192.168.0), then PC-1 can not access Camera-1 through inner link, so we should change Camera-1's IP into 192.168.0.126;

- 2) **computer and camera are in different LAN, but both can access internet**

Refer to picutre3 camera-1 and computer-2, if we want to access camera-1 through computer-2, then need to configure some settings following 1), to confirm

computer-1 can access camera-1, then configure router-1 (do port forwarding in router-1), to transfer the computer-2's access apply to go through router-1 then to camera-1. Normally, computer-2 only can reach router-1 without port forwarding for camera-1.

4.3 Connect network via ADSL

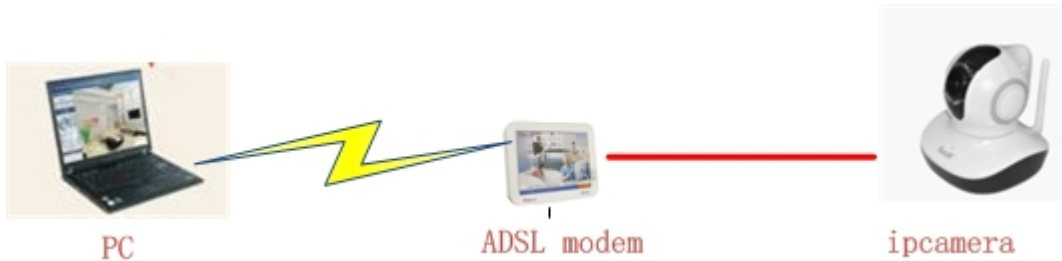

ADSL Settings	
Using ADSL Dialup	<input checked="" type="checkbox"/>
ADSL User	<input type="text"/>
ADSL Password	<input type="text"/>
<input type="button" value="Set"/> <input type="button" value="Refresh"/>	

- ❖ Connect camera to router through cable.
- ❖ Configure parameters via IP Camera tool (refer to: [5.1 IPcamera tool](#)).
- ❖ Login device by administrator, access PPPOE settings page to input user and password..
- ❖ After information input click “Set” by enabling DDNS service meanwhile to restart device.(refer to: [5.6 DDNS configuration](#))
- ❖ Connect to internet via ADSL then we can access camera by domain name link through internet.

4.4 Access network through router

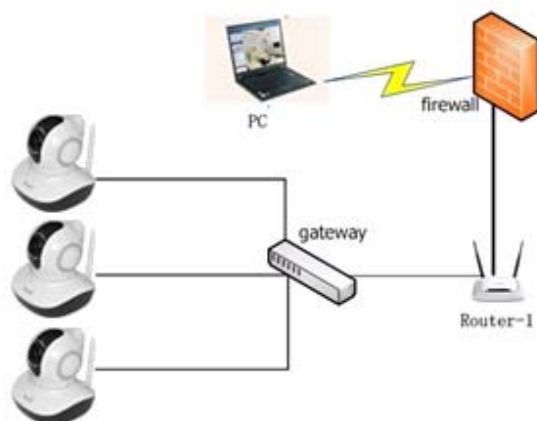

- 1) Connect device to LAN via cable
- 2) Configure device's parameters.(refer to: [5.1 IPcamera tool](#))
- 3) Access device with administrator.
- 4) Access ddns settings page to enable DDNS service then click “Set” to restart device. (Refer to: [5.6 DDNS configuration](#))
- 5) Access with ddns link through internet.

5. Software operation

5.1 IPcamera tool

In picture 3, camera-1 and computer-1 are in different subnets, run Devfind.exe in CD, click search, then select searched IP Camera to modify the parameters, refer to picture 4.

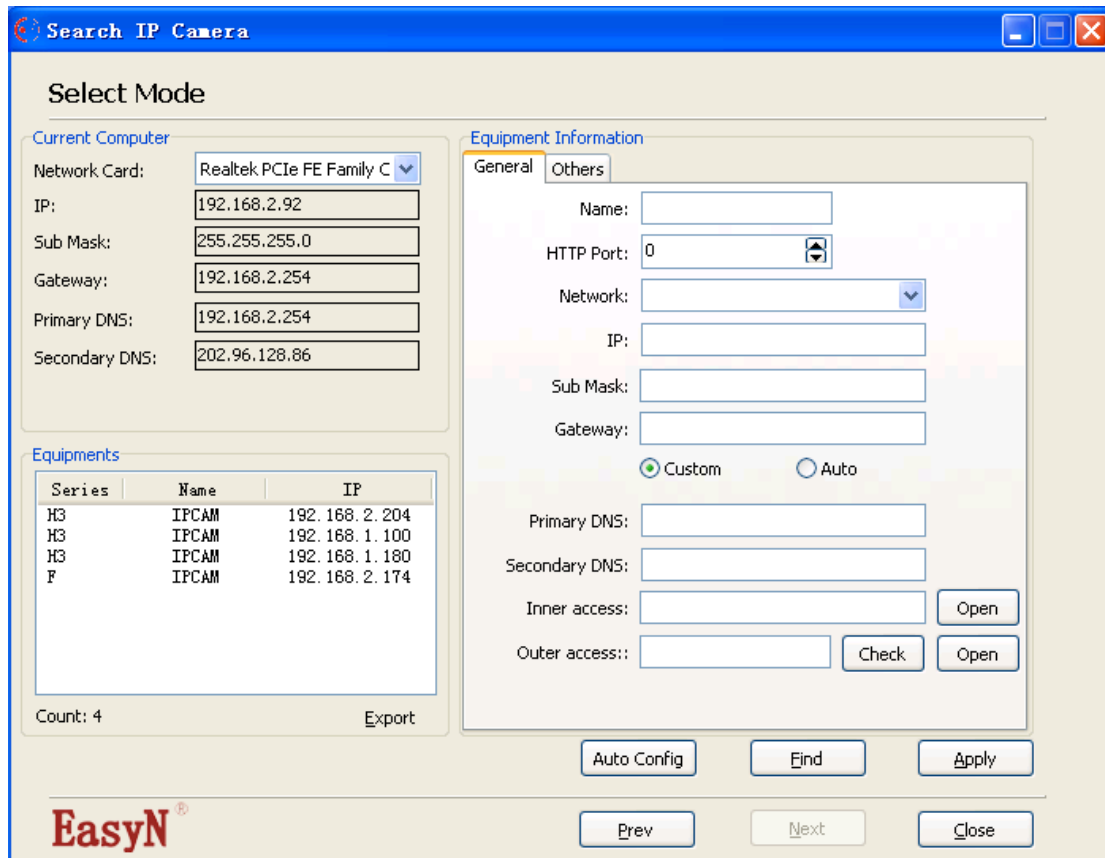

Picture 4- LAN configuration interface

Note: the default parameters of camera: **IP 192.168.1.126**, port **81**

Details:

- ❖ Please notice left-up side interface the current parameters of computer, it shows the basic network parameters of computer-1, if the computer has more than one network adapters, please select the right adapter the camera-1 working on.
- ❖ IP address: input IP address, the IP must be in the same subnet with computer.
- ❖ Mask: default mask: 255.255.255.0
- ❖ Gateway: confirm the gateway to be the same one for camera and computer
- ❖ DNS: DNS server IP address
- ❖ Port: the HTTP service port of device, default is 81
- ❖ User and password: default account is user: admin no password

5.2 Login device

IPCAM can be accessed from “open” function in camera finder or directly by inputting access link (IP added port) via browser.

The two sentences should be in ,same size,same font ,right?

IP Camera

For IE, FireFox, Google, Safari Browser

Sign in ← [click here for computer](#)

Mobile Phone (For Browser that supports Javascript)

Sign in ← [click here for mobile phone](#)

iPod touch / iPhone 2G, 3G, 3GS, 4 and iPad dedicated

Sign in ← [click here for Iphone or Ipad](#)

Language

do not show next time

Picture 5 login interface

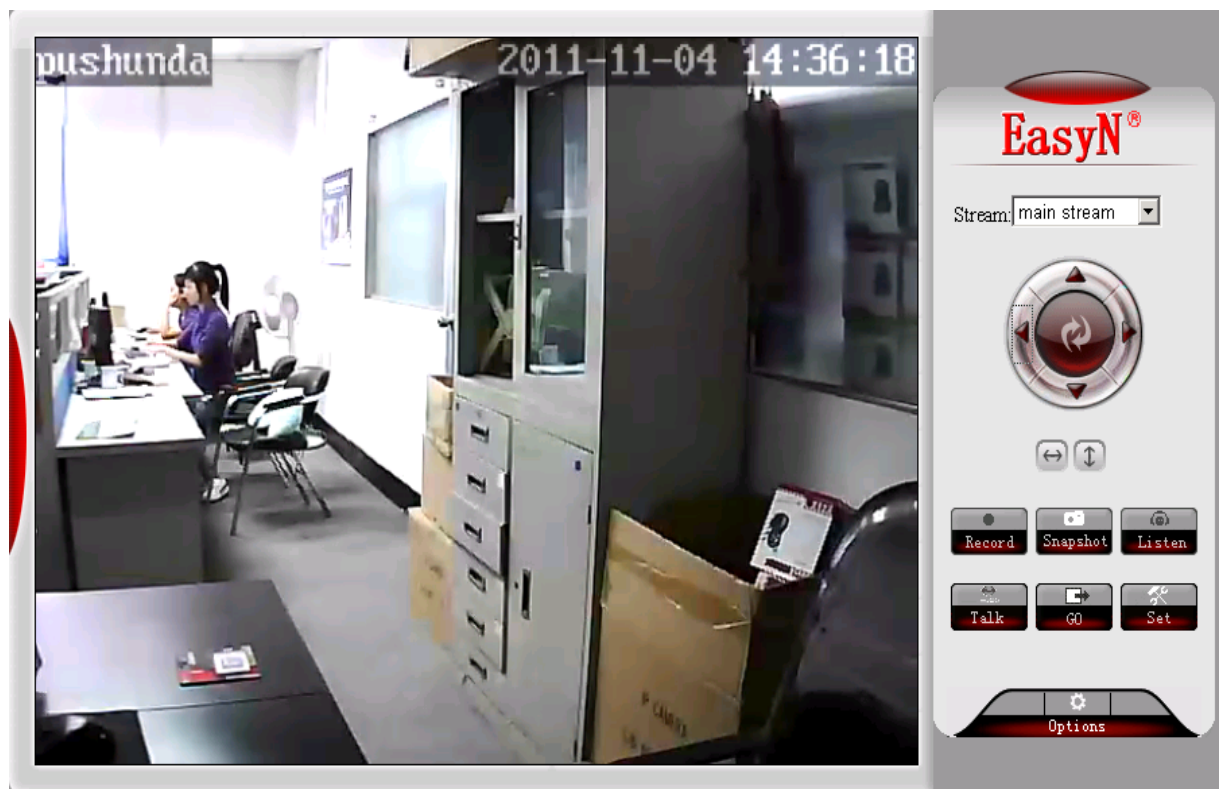

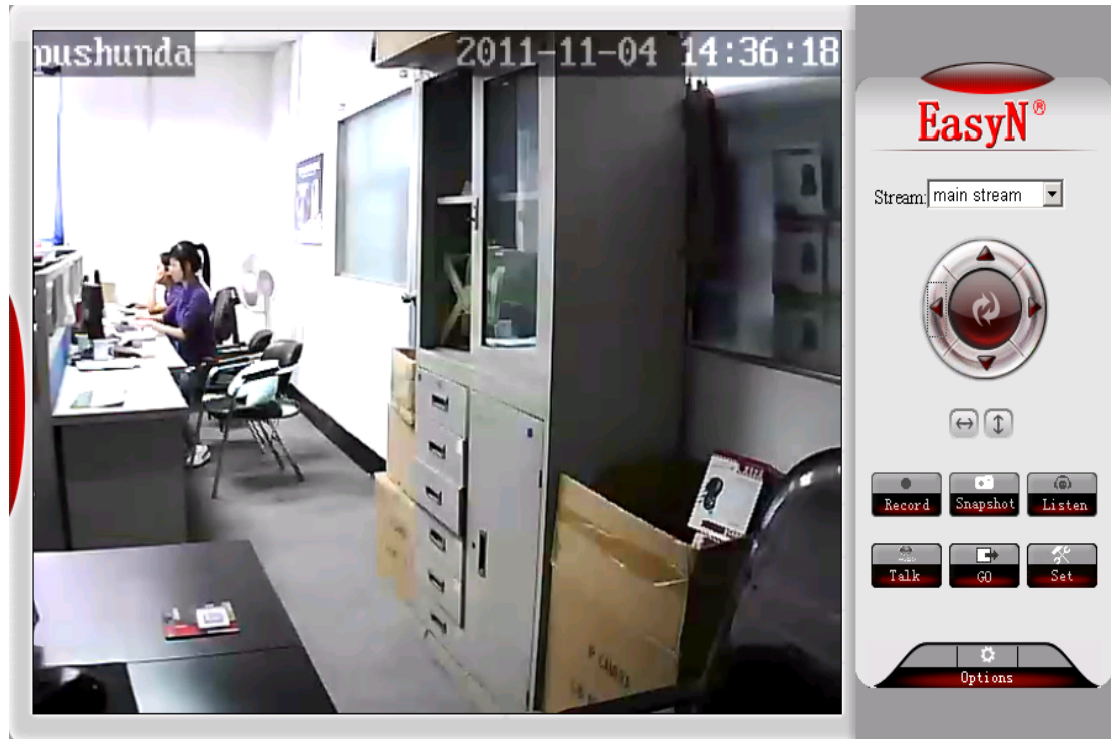

5.3 Operations



Record: click 

Snapshot: click 

Listen: click , it will change into , then we can listen sound coming from camera terminal on computer monitoring interface, click again to disable the function.

Talk: click , it will change into , then we can talk to camera terminal via headset on computer terminal. Click again to disable the function.

5.4 Basic network configuration

❖ Basic network configuration

IP address: it can support manually modifying IP, mask, gateway, DNS, etc.

Http port: In most cases, the default port is 81. but if the current network limits the port, we should select other port ranged 0 to 65535, such as 8080, 85, 8888, etc.

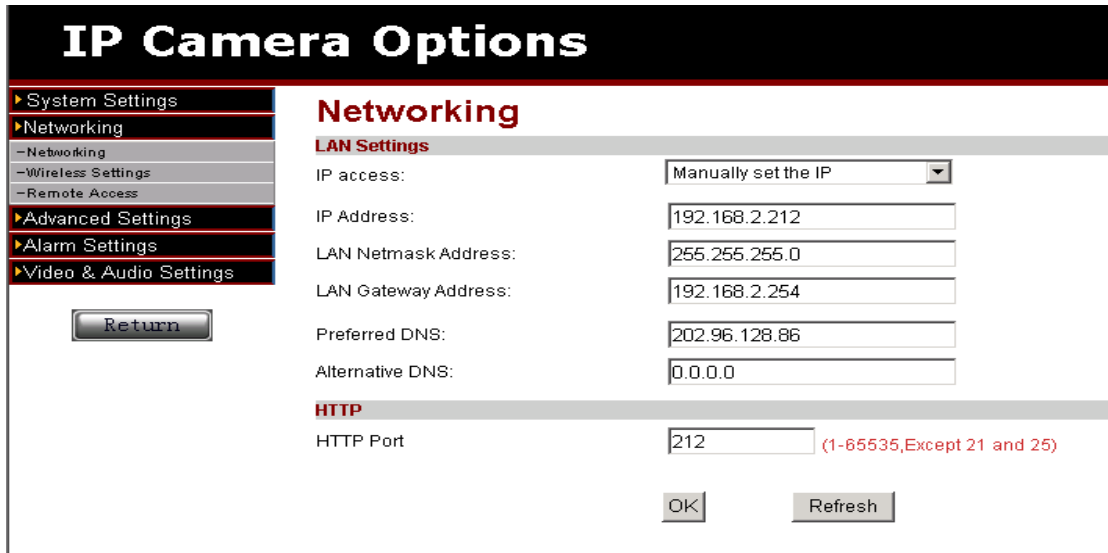

The screenshot shows the 'IP Camera Options' web interface. The left sidebar contains a menu with 'Networking' selected. The main content area is titled 'Networking' and is divided into two sections: 'LAN Settings' and 'HTTP'. In the 'LAN Settings' section, there are fields for 'IP access:' (set to 'Manually set the IP'), 'IP Address:' (192.168.2.212), 'LAN Netmask Address:' (255.255.255.0), 'LAN Gateway Address:' (192.168.2.254), 'Preferred DNS:' (202.96.128.86), and 'Alternative DNS:' (0.0.0.0). The 'HTTP' section has an 'HTTP Port' field set to 212, with a note '(1-65535, Except 21 and 25)'. At the bottom, there are 'OK' and 'Refresh' buttons.

Picture 10- network parameters configuration

❖ Wireless network configuration

The settings interface as picture 11, click “search” button, then it will pop up a page to display list of searched wifi network, select the network to join in, the parameters of the network will fill in the options blank (such as SSID, encryption algorithm, etc), user need to input password and confirm password. After configuration, click “set” button.

Note: please cable connect device before configuring wifi, after set, restart device to enable wifi function.

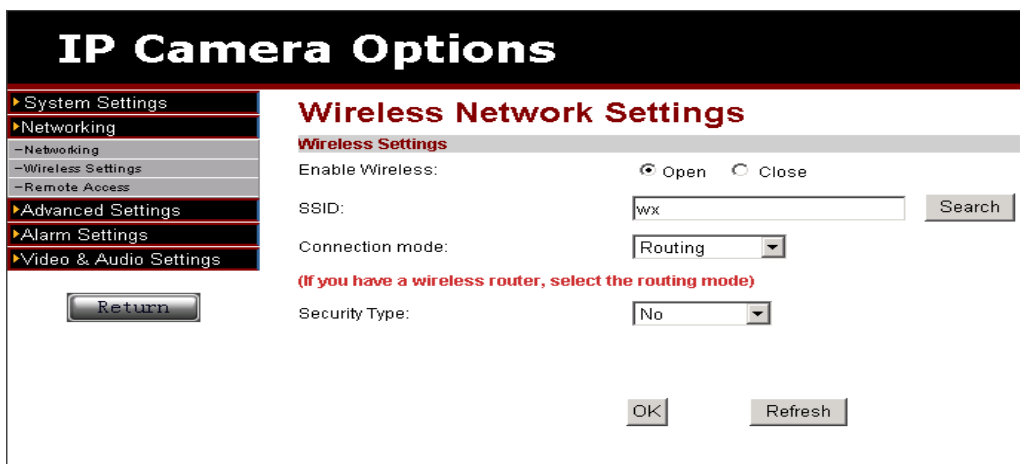

The screenshot shows the 'IP Camera Options' web interface. The left sidebar contains a menu with 'Networking' selected. The main content area is titled 'Wireless Network Settings' and is divided into two sections: 'Wireless Settings' and 'Enable Wireless'. In the 'Wireless Settings' section, there are fields for 'Enable Wireless:' (radio buttons for 'Open' and 'Close'), 'SSID:' (wx), 'Connection mode:' (Routing), and 'Security Type:' (No). A note '(If you have a wireless router, select the routing mode)' is present. At the bottom, there are 'OK' and 'Refresh' buttons.

Picture 12- wifi configuration

5.5 DDNS configuration

In picture 3, router-1 obtain wide area network IP address through ADSL, the IP address is dynamic, we could not know the real-time IP address of the device from internet, therefore, we need to obtain the address through DDNS server in internet, camera-1 will send message to the DDNS server for each defined-interval time, the DDNS server analyze the IP address of router-1 it connected, then we can obtain the IP address from DDNS server. Therefore, the domain name stands for the dynamic IP address, if the device can not be found by IP address, the domain name is not available.

❖ Manufacture DDNS settings

The manufacture has set up DDNS server in internet, and distributed domain name for each device, the domain name has build in device, as picture 13. Input the domain name link to browsers, the link will change into the real IP address of the device and start to connect device.

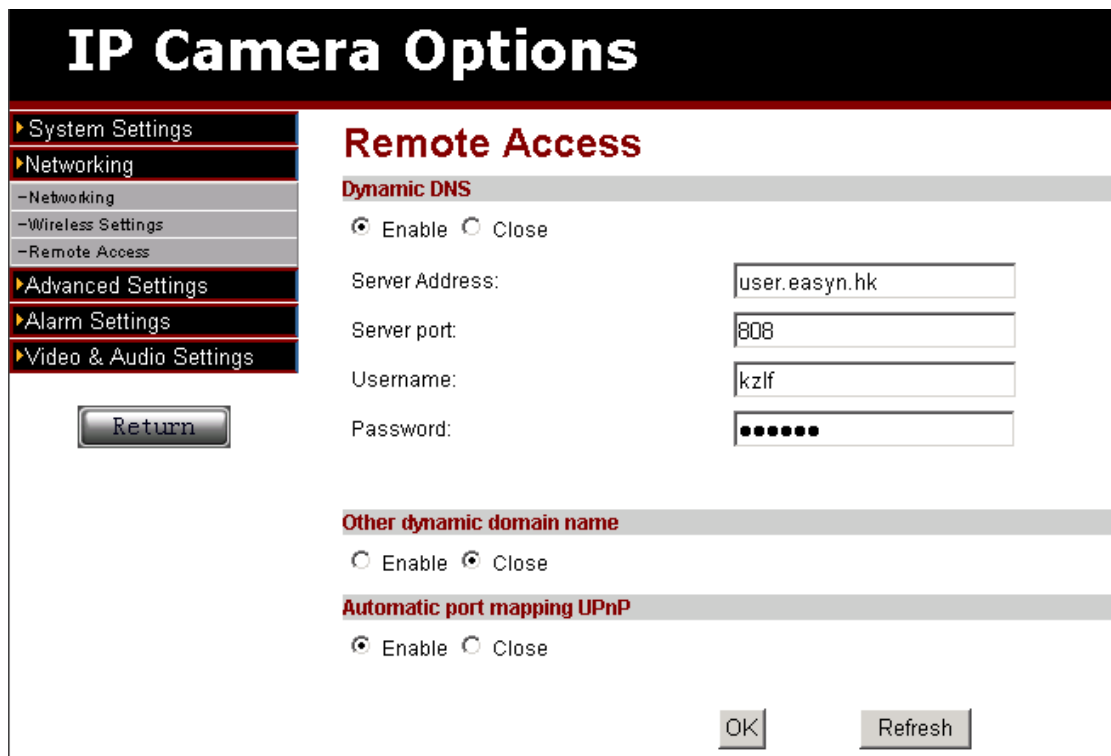

The screenshot shows the 'IP Camera Options' web interface. On the left is a navigation menu with categories: System Settings, Networking (selected), Advanced Settings, Alarm Settings, and Video & Audio Settings. Under 'Networking', there are sub-items: Networking, Wireless Settings, and Remote Access. A 'Return' button is located below the menu. The main content area is titled 'Remote Access' and contains three sections:

- Dynamic DNS:** Includes radio buttons for 'Enable' (selected) and 'Close'. Below are input fields for 'Server Address' (user.easyn.hk), 'Server port' (808), 'Username' (kzlf), and 'Password' (masked with dots).
- Other dynamic domain name:** Includes radio buttons for 'Enable' and 'Close' (selected).
- Automatic port mapping UPnP:** Includes radio buttons for 'Enable' (selected) and 'Close'.

 At the bottom right of the configuration area are 'OK' and 'Refresh' buttons.

Picture 13- DDNS configuration

Note 1: the ddns function is realized by transferring method, when access device through domain name link, it will automatically change into device's IP and port.

Note 2: if the device can be accessed by IP address but not domain name link, please verify the DNS configuration if it is available, and confirm the DNS is the same with LAN settings.

❖ Third party DDNS configuration

The product also can support third party DDNS, such as Oray.

Note: the third party DDNS realizes the function by analytical methods, after inputting the ddns in browser, the characters would not change, if the port is not 80,

need to add a colon and port behind the ddns, such as:

<http://easyn.3322.org:81>

5.6 E-mail service configuration

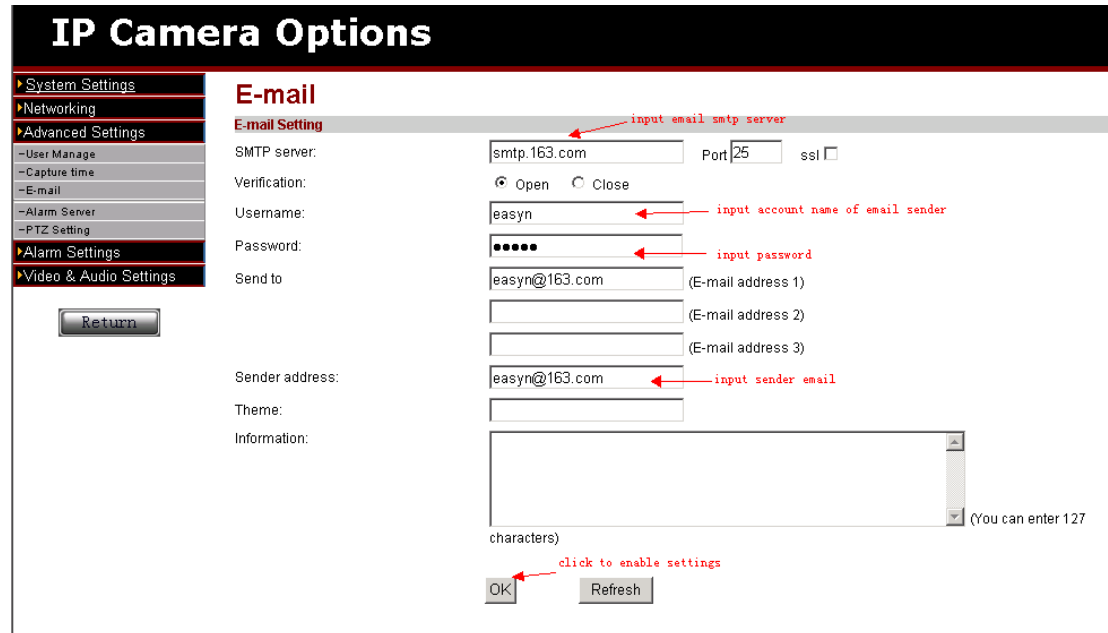

Picture 14- email service configuration

The information in picture 14 is must, if some options are not correct, the settings would not work.

Note: it is best test the settings in *Outlook Express* before configuration to confirm the settings working.

- ❖ **SMTP:** input e-mail SMTP server
- ❖ **Sender address:** e-mail address to send mail
- ❖ **Receiver address:** e-mail address to receive snapshot and IP address. It can support 4 receivers.
- ❖

6 Central Management

6.1 Installation

1.Requirement

Hardware condition:

- 1、 Pentium IV series, CPU frequency above 2.0G
- 2、 memory above 2G
- 3、 hard disk >= 120G
- 4、 monitor 1024×768 or above



Software condition:

Windows2000/WindowsXP/Windows2003/Windows Vista/Windows 7, recommendation Windows XP

6.2 Installation steps

Double click installation package, it pops up as below:

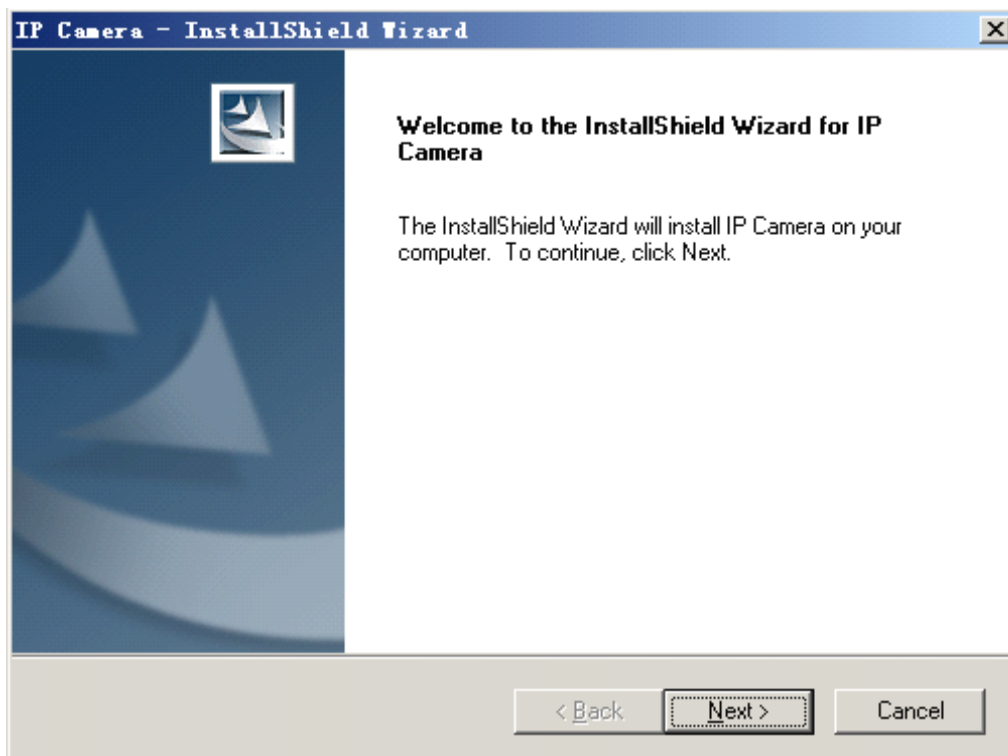

Select path then click “next”.

After installation, it creates an icon on desktop as below:



At program list as below:

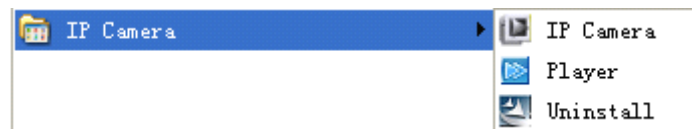

6.3 Login and Logout

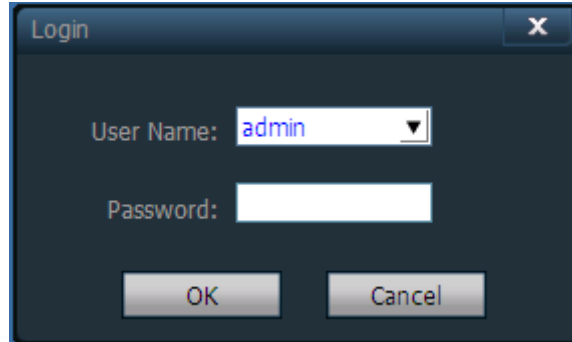

【Login】 the default user is admin and no password, click “ok”to access software main interface.

【Logout】 only admin authority can logout, user and guest authority can not

It needs to input administrator user and password when logout.

6.4 Software interface

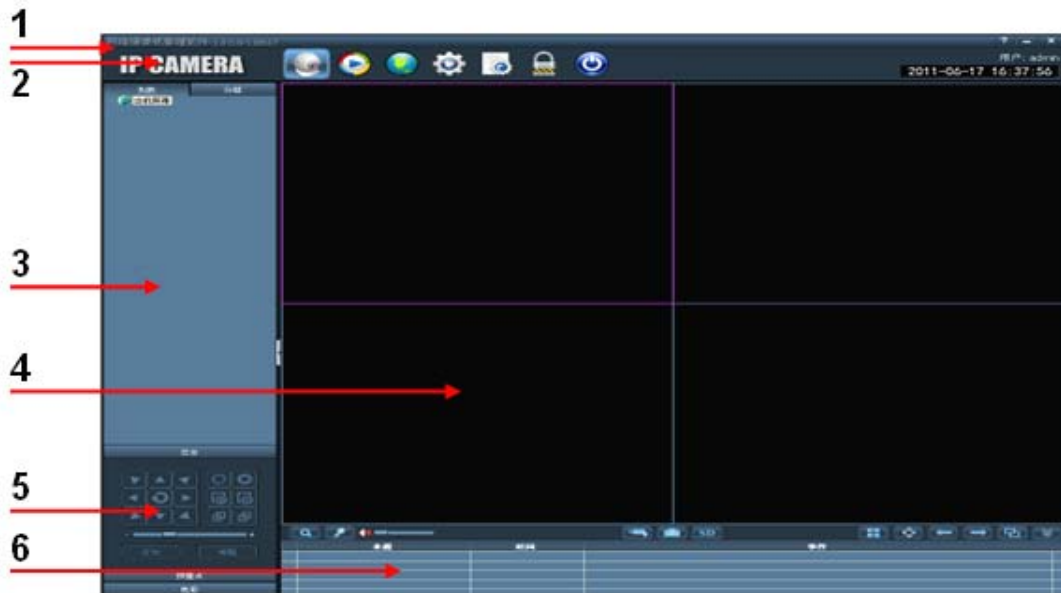

Software interface includes six blocks:

1 system button list

2 label list

3 devices list

4 real-time preview

5 PTZ control

6 alarm info list

◆ system button list:

Ⓜ help button, click to open client use manual

■ hidden button, click to hide software to system hidden list

✕ exit button, click to pop up logout dialog

◆ label list:



LOGO information



Click to change to preview interface



Click to change to playback interface



Click to change to map operating interface



Click to change to configuration interface



Click to change to log operating interface



Logout or change user



Click to logout

◆ Devices list:

- 【List mode】 display area, settings and channel from user set
- 【Group mode】 display group and channel from user set
- 【Current screen】 display devices current screen connected, only available on List mode

◆ Real-time preview:



electronic enlarging button, circle an area after click to enable



audio talk button, select the right window then click button to enable, only support unique device to talk at one time



Listen button, click to enable/disable listen, support multi-listen



Record button, select the right window, click to enable/disable recording



Snapshot button, select the right window, click button to snapshot, support to snapshot twice in one second



SD card button, select window, click button to open SD card page to see inside information



Multi-picture button, click to enable multi-picture view



Full screen button, click to full-screen view of real-time-area view



Front group button, click to show the front group view on circleview mode



Next group button, click to show the next group view on circle view mode

 Circle view button, single click to enable/disable

 Devices list fold/unfold button, click to fold/unfold

 Alarm information list fold/unfold button, click to fold/unfold

2.3 DEVICE MANAGEMENT

2.3.1 Add device

Firstly click “Config” button on label list to access device management page.

6.5 Device management

1. Add device

Firstly click “Config” button on label list to access device management page.

【Add list】

- ◆ At first time run, the default list is null, click “Add Area” button, pop up “Add Area” dialog, and input a name on name blank to add an area into device list. That is the first area, so there is no belonging area of it, it means the belonging area is null.

Notice: it can support 128 areas presently

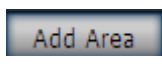
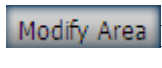
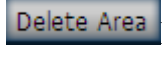
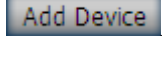
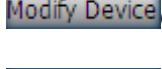
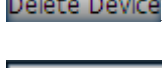
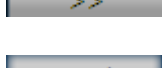
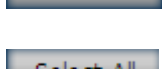
-  Add area into device list
-  Modify name of selected area
-  Delete selected area
-  Add device manually
-  Click to pop up configuration dialog
-  Delete selected device
-  Add searched device into selected area
-  Click to search devices in LAN
-  Select all devices in list

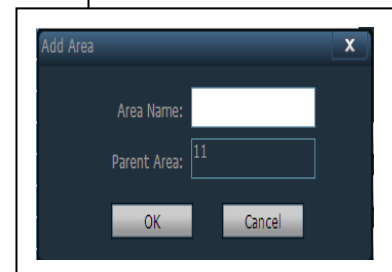

【Add device】

- ◆ Search and add device in LAN:

Click search button, then select device in search list to add, click

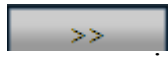
 button to add device to area.

- ◆ Add device manually:

Click  button then pop up add device dialog, as below:



【Name】 Device name, support custom, length less than 30 byte.

Only display name instead of IP after input name.

【Channel】 Support different channel on case that one device has many channels, presently device only supports one channel.

【IP or Domain name】 Device IP or domain name

【Port】 Device http port, default is 80

【User name】 Device login name, default is admin

【Password】 Device login password, default is admin

【Area】 Device displaying area

After input all needed information, click OK button to finish ADD

2.3.2 Group management

- ◆ Add group:

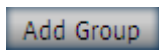
Click  button, input group name into pop-up dialog then click OK
Notice: support 20 groups



- ◆ Configure group

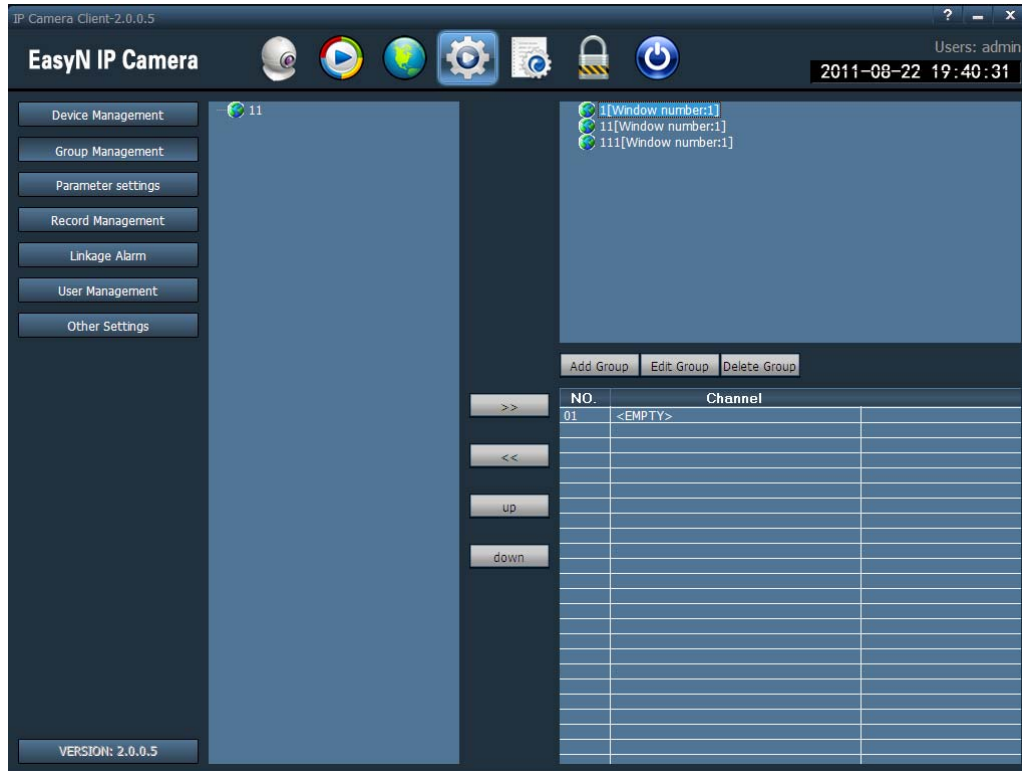

After add groups, configure groups

Configuration: select group, click “+” in front of device IP or name, then select

Channel 01, click  button to add device channel to group.

Notice: single group can support 16-picture view

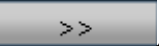
 Add device channel to the group

 Remove the device channel from the group

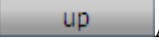
 Adjust the order to display devices in the group, selected device exchanges position with the front device

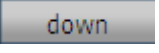
 Adjust the order to display devices in the group, selected device exchanges position with the next device

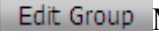
 Modify the group name and numbers of multipicture, clear group after modifying, need to create new group

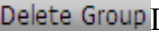
 Delete group and devices in the group

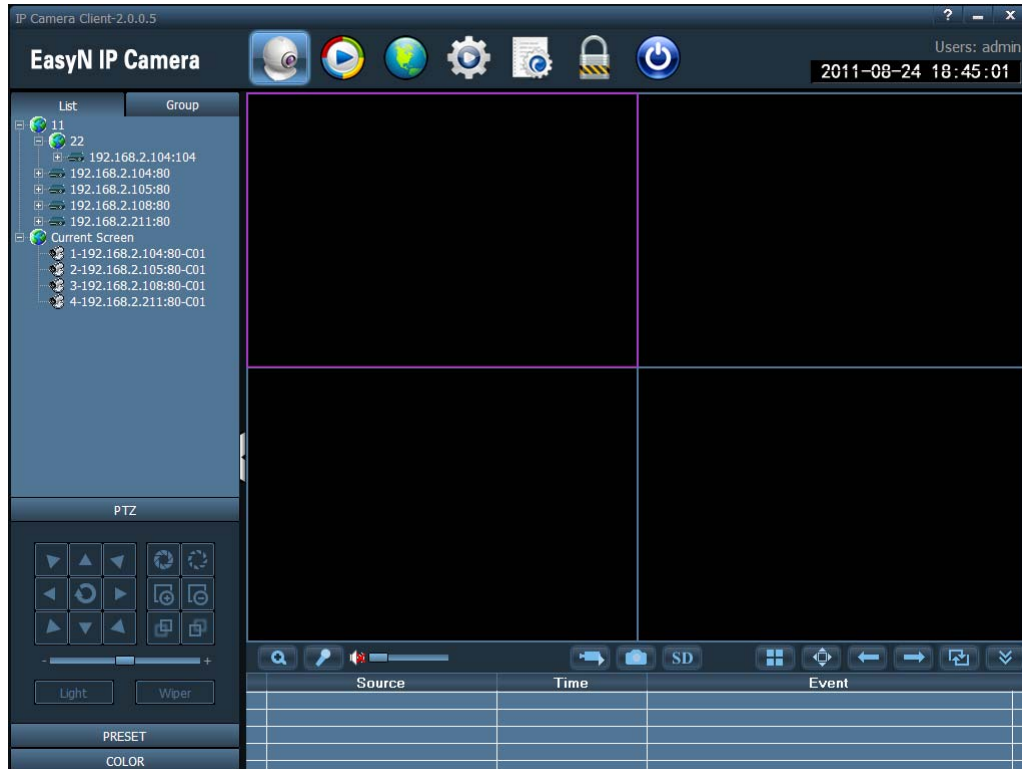

6.6 Image preview

After device configuration, click “Preview” button to access main interface, devices list displays as list tree, click “group” or “list” to exchange information of group or list. Default viewing screen is 4-picutre, max support 16-picutre view.



1. Non-cycle preview



Click “+” in front of device’s name or IP, then double click Channel 01 or drag Channel 01 to the window to view video. It displays a blue triangle  after device connected Channel 01, if the display as , it means device does not connect. And if the display as , it means there is alarming. Right click on one area, it pops up dialog as:

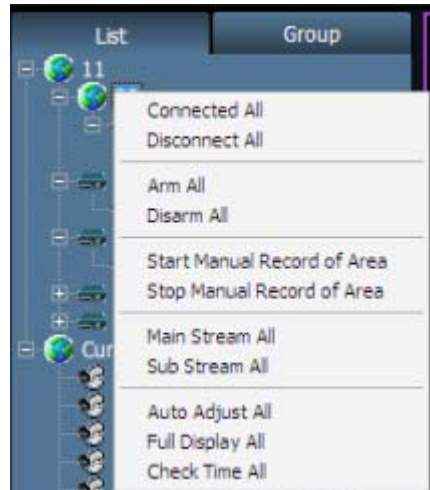

【Connected All】 connect device in selected area

【Disconnected All】 disconnect device in selected area

【Arm All】 devices in selected area arm

【Disarm All】 devices in selected area disarm

【Start Manual Record of Area】 enable manual record in selected area

【Stop Manual Record of Area】 disable manual record in selected area

【Main Stream All】 connect device with main stream in selected area

【Sub Stream All】 connect device with sub stream in selected area

If device is in connection, it should be disconnected then reconnect, then the stream changes to sub stream, otherwise, it is still in main stream.

【Auto Adjust All】 device in selected area auto adjusts view proportion

【Full Display All】 device in selected area adjusts image proportion according to the size of window of multi-picture view.

【Check Time All】 device in selected area synchronize time with PC.

Notice: Please double click Channel 01 below device or drag Channel 01 to window to view video.

Select one device; right click on Channel, pop-up dialog as:

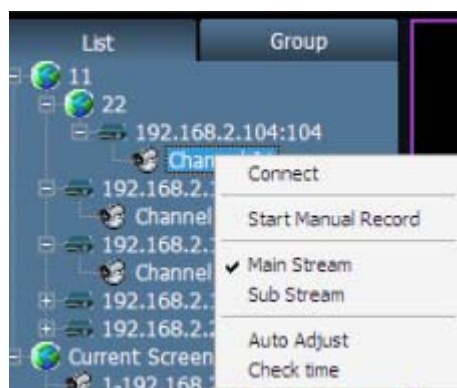

【Connect】 connect one channel of selected device, only support Channel 01 presently.

【Start Manual Record】 enable manual record for selected channel, label auto

changes into label of disable-manual-record label.

【Main Stream】connect device with main stream, on tick means current selection is main stream.

【Sub Stream】 connect device with sub stream, on tick means current selection is sub stream.

【Auto Adjust】 selected channel auto adjusts view proportion

【Check Time】 selected channel synchronizes time with PC.

Right click on preview window, pop-up dialog as:



【Full Screen】 select full screen for software full screen view, double click to view full screen for single window.

【Auto Adjust】 on tick to display according to image proportion, off tick to display according to window's size of multi-picture view.

【Photo】snapshot selected window then save to hard disk, default format is JPG.

【Record】 enable manual record for selected window, auto on tick Record

【Stop Display】 stop display for selected window

Notice: after stop display, device is still in connection, if device is on recording, it keep recording after stop display.

2. Cycle preview

Only support cycle mode to view video on group list mode, it needs to set groups before enabling cycle mode, details refer to instruction of “Group Management”.

Click  enable cycle mode, click again to disable cycle mode.

For cycle mode view, to set cycle time, click “Config” then “Record Management” to configure cycle time, default value is 5 seconds.

6.7 PTZ control

1. PTZ control

We can move PTZ to 8 directions through controlling direction buttons, and drag the slider to change PTZ moving speed, “-” is for slowing, “+” is for accelerating.



Enlarge aperture, need device hardware support



Narrow aperture, need device hardware support



Enlarge focus, need device hardware support



Narrow focus, need device hardware support



Focus forward adjustment, need device hardware support



Focus back adjustment, need device hardware support

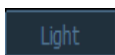

Light button, click to light on/off, need device support

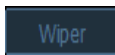

Wiper button, click to wiper on/off, need device support

2.5.2 Preset position configuration

Client software supports 256 preset positions, for actual amount of preset positions, it depends on camera supported.

PRESET	
NO.	PresetName
001	Preset001
002	Preset002
003	Preset003
004	Preset004
005	Preset005
006	Preset006
007	Preset007
008	Preset008
009	Preset009
010	Preset010

Goto Set Del

【Set preset position】 Select window to set preset position, then select preset position number, click “Set” button.



【Goto preset position】 Select window to call preset position, then select preset position number, click “Goto” button.

【Del preset position】 Select window to delete preset position, then select preset position number, click “Del” button.

1. Image color configuration

Click “Color” button to access image color adjustment dialog.

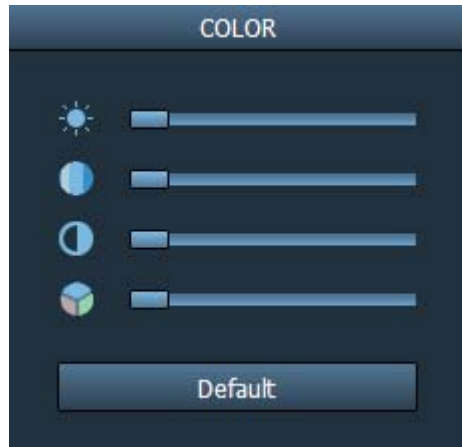

Adjust image brightness



Adjust image white balance



Adjust image contract



Adjust image color



Recover to factory set color

6.8 Video management

1. Plan of record

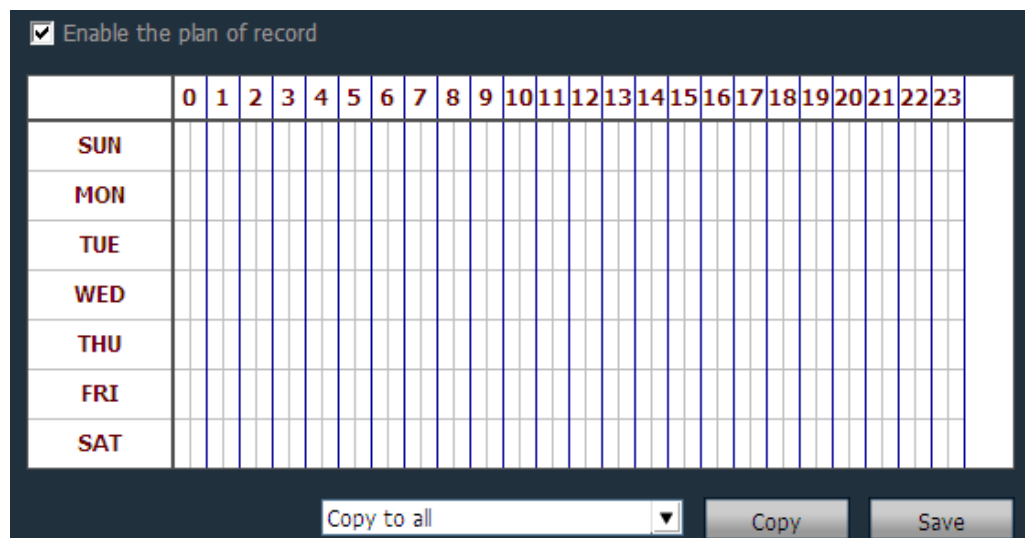

Click “Config”, then “Record Management”, then tick “Enable the plan of



record”, picture as above:

【enable plan record】 Select channel to record, then left click to drag out a green box(the box range is the time to record). Click “Save” to finish.

【disable plan record】 Untick “Enable the plan of record”, then click “Save”. Or cancel the green box then click “Save”. Left click on green box then drag mouse to cancel.

Notice: if to set same plan to all devices, click “Copy” then “Save” after set up one device, then all devices enabling plan.

【General Record Length】 Single record file’s size, the factory set is 5-min size, single record file’s size can be 1-60 minutes. To modify size in General Record Length blank then click Save.

General Record Length: 5 (1-60min)
 Alarm Duration Time: 10 (5-60Sec)
 Switch Interval: 5 (5-60Sec)
 Pre-recorded alarm Length: 5 (1-15Sec)

【Recovery of remaining disk】 The selecting range is 1-10G, when space is less than selected range, it should save record to another disk or cover the former records.

The remaining disk begins recovery
 1 GB
 Record Format: 264
 No hard disk space cover

【Record format】 It can support 264 and AVI formats, and for 264 format, only can play with factory player.

【Cover disk after fulfill】 Tick to enable deleting the most former record when all disks space are less than selected recovery space. If no tick, recording stops when all spaces are less then selected recovery space.

	Disk	Total size(G...)	Available si...	Path
<input type="checkbox"/>	C:	36.638	32.472	C:\MediaRecord\
<input checked="" type="checkbox"/>	D:	63.420	42.554	D:\MediaRecord\
<input type="checkbox"/>	E:	65.908	56.870	E:\MediaRecord\
<input type="checkbox"/>	F:	66.858	60.104	F:\MediaRecord\

【Record Save Path】 Software auto detects and lists on tablet after set-up. The

default path is D:\.

Note: Software can support 20 pieces of disk partitions.

1. Alarm Record

◆ Alarm Type:

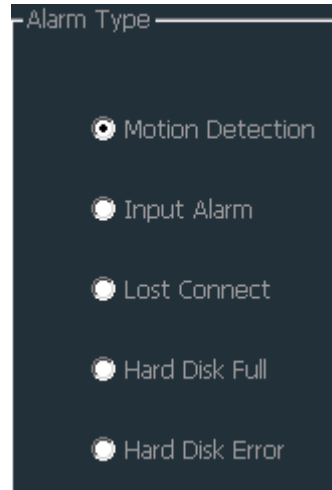

【Motion Detection】 Alarm on motion detection

【Input Alarm】 Alarm on external input signal

【Lost Connect】 Alarm on lost connection

【Hard Disk Full】 Alarm on hard disk is full

【Hard Disk Error】 Alarm on hard disk error

◆ Linkage Alarm:

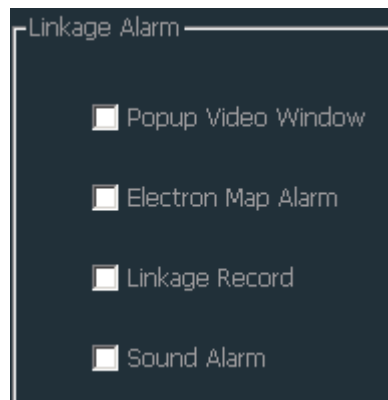

【Popup Video Window】 Tick for popping up windows on alarm

【Electron Map Alarm】 Tick for flashing on electron map on alarm

【Linkage Record】 Tick for recording to local disk on alarm

【Sound Alarm】 Tick for displaying sound on alarm

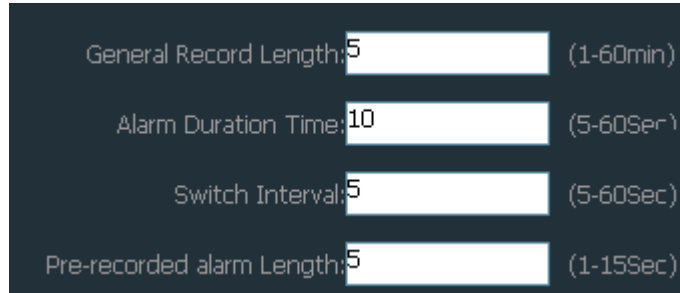

【Alarm Duration Time】 Alarm duration time, default is 10 seconds, selecting range is 5-60 seconds.

【Pre-recorded alarm Length】 Pre-recording's length on alarm, default is 5 seconds, selecting range is 1-15 seconds.

◆ Arm and Disarm

【Arm】 Press “Preview”, select area or device for arming, after arming it will display  logo in front of device IP or name.

【Disarm】 After disarm, logo  disappears.

Note: 1. Linkage alarm only is available on arm condition, if device disarms, linkage alarm is not available.

2. If new alarm happens on alarm, the alarming time should extend.

3. Motion detection and input alarm can linkage popup video window; electron map alarm, linkage record and sound alarm, others only support sound alarm.

1. Manually Record

Select monitoring windows, click  button or right click on windows to select to record, for recording time and path, referring to schedule record.

Record priority:

1. If enable schedule record and alarm record at the same time, it triggers alarm in schedule alarm, system should stop schedule alarm and runs alarm linkage record.

2. If enable schedule record and alarm record at the same time, then enable manually recording when alarm linkage record happens, system should stop schedule record and alarm record, and run manually recording.

6.9 Playback

1. Playback by searching time

 Play button; press this button for playing record

 Pause button; press this button for pause

 Single frame play; press this button for single frame play, one click one frame picture



 Snapshot button; select windows then press this button for snapshot

 Enlarge button; press this button then select area for enlarging on windows

 Full screen button; press this button for full screen show, double click on single windows for one windows full screen

 Drop down options for selecting playing speed, default is normal

 Sound button; click to sound on/off, default is closed

 Input time point then click  to go to selected time to start playing

【Record search】

All Record						
2011/09						
SUN	MON	TUE	WED	THU	FRI	SAT
				01	02	03
04	05	06	07	08	09	10
11	12	13	14	15	16	17
18	19	20	21	22	23	24
25	26	27	28	29	30	

Step 1: define file type and searching time

Step 2: select windows to playback, then select device channel on list tree

Step 3: if there is record file matching to searching condition, the file should display on timeline forum, then double click on channel to playback

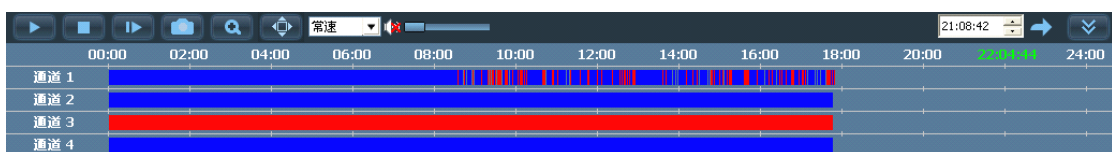

Schedule record:  alarm record:  manually record: 

Note: move the mouse on timeline, it will display time point of current position, click to view the video; right click on timeline, the display length should turn into 2-hour from 24-hour, it means the time point extending

2. Searching-file Playback

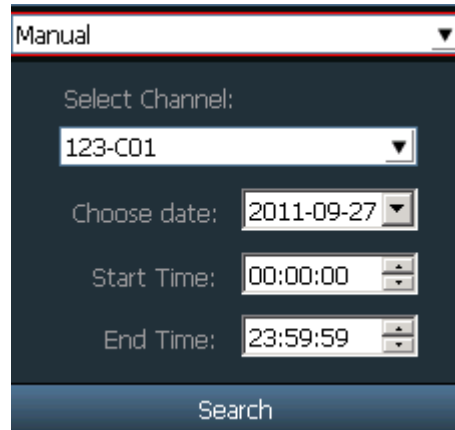

Step 1: select file type and device channel

Step 2: select searching time then click “Search”, the eligible files should list on device tree

Step 3: select playback windows then double click record file to view video, it can support one video displaying on four windows at the same time

6.10 Electron map

1. add map

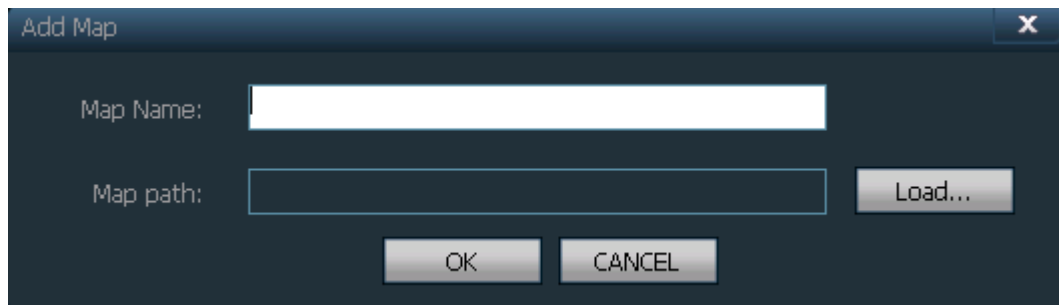

Step 1: click “Add Map” or right click to select “Add a new map”

Step 2: input map name in dialog “Map Name”, then load map

Step 3: click “OK” to add map to software

2 Edit Map

After added map, then go to edit map

Step 1: click “Edit Map” on map, or right click to select edit map

Step 2: drag device channel to map, then it displays , double click on it to view image

Step 3: after edit, click “Stop Editing”

It needs to enable “Electron alarm map” of alarm linkage for logo flashing

3 Delete Map

Select map name then click “Delete Map” to cancel map

6.11 Parameters configuration

To connect device for configuration on parameters configuration page (double click device channel, the image should display on right side image frame).

1. Color



【Brightness】 drag slider to select best brightness

【Saturation】 drag slider to select best saturation

【Contrast】 drag slider to select best contrast

【Hue】 drag slider to select best color

【Default】 click to load default value

【Flip】 tick for image turnover(need device support)

【Mirror】 tick for mirror image(need device support)

【Scene】 white balance: support auto, indoor, outdoor. Default is auto(need device support)

【Infrared】 night vision: support auto switch, manually switch. Default is auto (need device support)

Note: it can not configure if device does not support that function.

2. Video

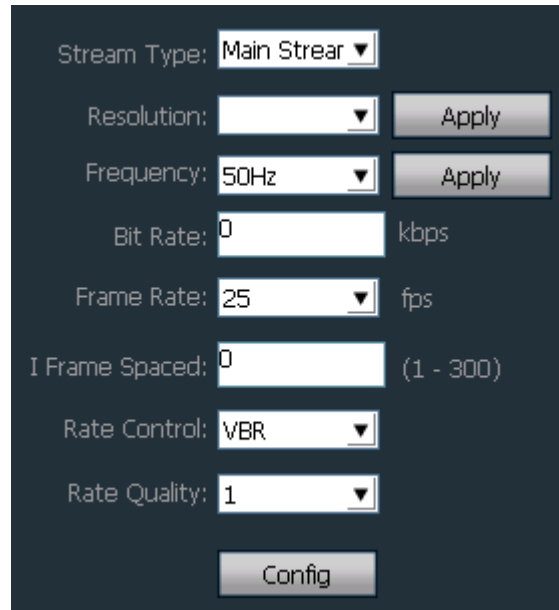

【Stream Type】 support main stream and second stream

【Resolution】 different resolution for different model

【Frequency】 support 50Hz and 60Hz, default is 50Hz

【Bit Rate】 different bit rate for different model

【Frame Spaced】 N standard or 60Hz device has range 1-30fps, P standard or 50Hz device has range 1-25fps

【I Frame Spaced】 the interval of two I frame of image

【Rate Control】 support VBR and CBR

【Rate Quality】 support 6 levels, lower level with better quality

i. Audio

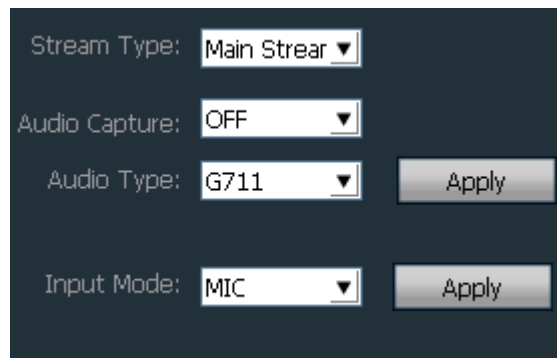

【Stream Type】 support main stream and second stream

【Audio Capture】 ON or OFF

【Audio Type】 G727, G711 and AMR

【Input Mode】 MIC or Line In

ii. OSD

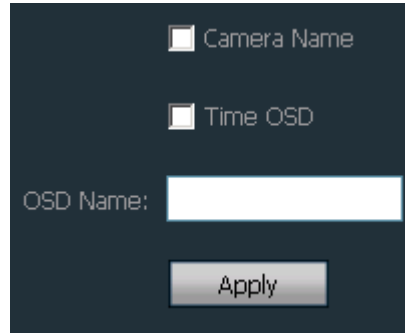

Camera Name

Time OSD

OSD Name:

Apply

【Camera Name】 tick to enable adding name on image

【Time OSD】 tick to enable adding time on image

【OSD Name】 input OSD name then click Apply button, it can support 18 bit

iii. Network



IP Address:

Sub Net:

Gateway:

Mac Address:

DNS Mode:

Primary DNS:

Second DNS:

Http Port: Apply

To configure network parameters on current condition, the software only displays network parameters of current device, despite it is manually configured or DHCP.

iv. Motion Detection

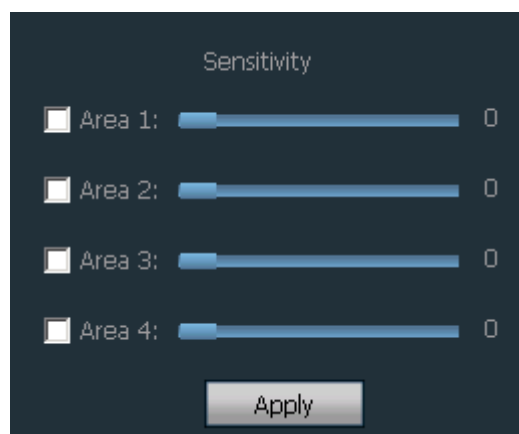

Sensitivity

Area 1: 0

Area 2: 0

Area 3: 0

Area 4: 0

Apply

Configure motion detection:

Step 1: tick area, then it display a green dialog on left image

Step 2: drag the green dialog to position wanted, and configure its size

Step 3: configure sensitivity of alarm area detection. Sensitivity range: 0-75, default is 35, the greater the value, the more sensitive, and vice versa.

Step 4: click “Linkage Alarm” to select alarm type

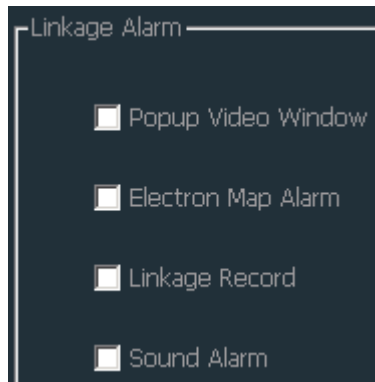

Step 5: enable arm function for device, otherwise it can not support alarm linkage

v. PTZ

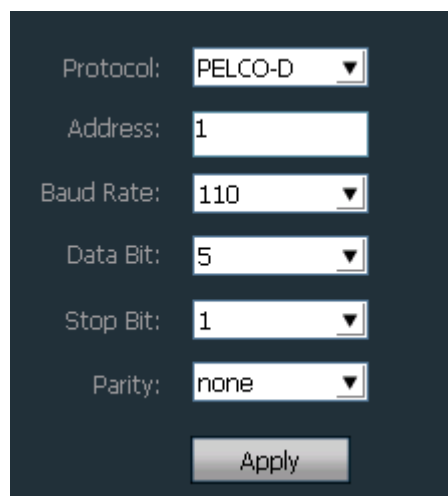

For ptz control, it should be fulfill with right parameters, different ptz has different protocol, protocol code and baud rate.

vi. System

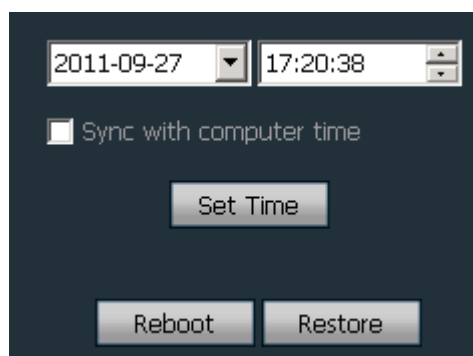

After select time, click “Set Time” to modify time of device

【Sync with computer time】 tick then click “Set Time” to enable

【Reboot】 click to reboot

【Restore】 click to restore factory settings, after restore, need to reboot to reconfigure network parameters of device for reconnection

6.12 User management

Factory set administrator name is admin, no password. Login with administrator then add, delete and configure user authority. User authority includes three levels: admin, user and guest.

“admin” authority: administrator, enable to manage device, manage user, view video, playback video, configure map, inquire log, and exchange user and exit software

“user” authority: enable to view video, playback video, configure map, inquire log, exchange user and modify password

“guest” authority: enable to view video, exchange user and modify password

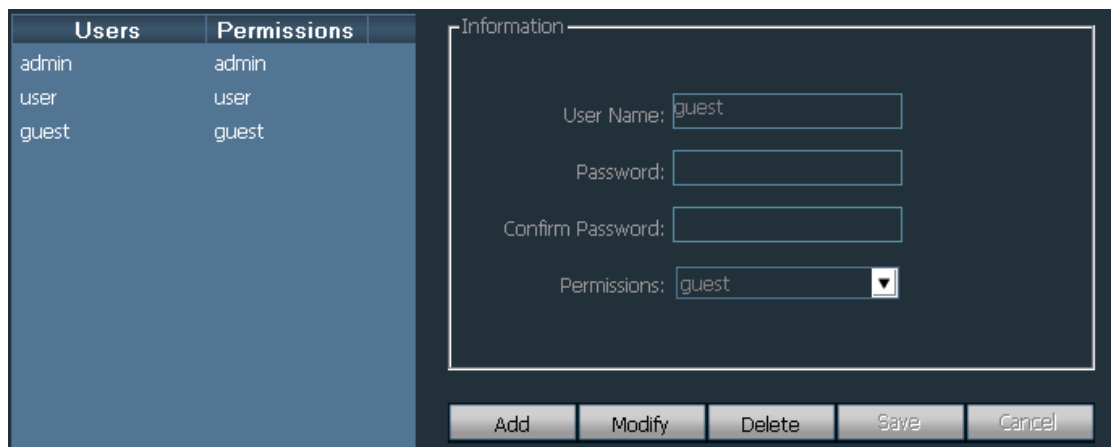

Users	Permissions
admin	admin
user	user
guest	guest

Information

User Name:

Password:

Confirm Password:

Permissions: ▼

2.10.1 Add User

Step 1: login with admin then click “Config” then “User Management”

Step 2: click “Add” button, input name and password then select permission

Step 3: click “Save” button to finish

2.10.2 Delete User

Step 1: login with admin then click “Config” then “User Management”

Step 2: select user then click “Delete” button

2.10.3 Modify User Authority

Step 1: login with admin then click “Config” then “User Management”

Step 2: select user then click “Modify”

Step 3: select permission then click “Save”

2.10.4 Modify User Password

Step 1: click “Config” then “User Management”

Step 2: select user then click “Modify”

Step 3: input new password then click “Save”

6.13 Log

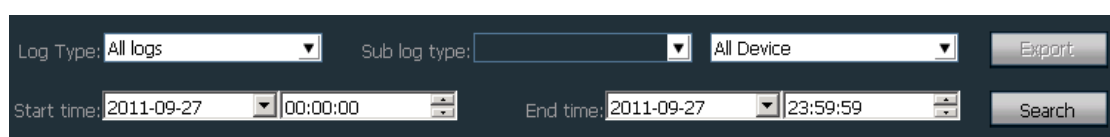

Log Type: Sub log type: All Device

Start time: End time:

Log Type:



【All logs】 record all information of system

【System log】 record information of user login, logout and user configuration, etc.

【Operation log】 record user operations

【Alarm log】 record device alarm information

2.11.1 Log Retention Time

Step 1: click “Config” then “Other Settings”

Step 2: select retention time for log, it supports 1, 2, 3 or 6 months, then click “Save” button

2.11.2 Inquire Log

Step 1: select log type and sub-log type

Step 2: select device for inquire log, default is “All Devices”

Step 3: select start time and end time then click “Search”

2.11.3 Log Backup

Step 1: select log type and sub-log type

Step 2: select device to inquire, default is “All Devices”

Step 3: select start time and end time then click “Search”

Step 4: click “Export” then select backup path

Note: 1. It should search log before backup

2. Exported log is with Excel format

3. Each Excel table only saves 5000 pieces of logs, extras will be saved as another Excel table, and so on

6.14 Other settings

00:00:00 Check Time

Log retention time: One Month ▼

Capture format: JPG ▼

Image capture path: D:\

【Multi-screen】 one computer host can support three monitors at the same time



- 【Time verify】 tick and configure time, software verify time to all devices at appointed time to match time on PC
- 【Snapshot format】 format of snapshot, support JPG and BMP
- 【Snapshot save path】 the save path of snapshot
- 【Save】 click “Save” button to enable configuration
- 【Exchange User】 click “Logout”, after that, click on other page to re-login

7 Port forwarding

Referring to picture 3, computer-1 can access camera-1, for computer in internet (such as computer-2, computer-3) to access camera-1, it needs to expose the camera-1 in internet, the method is to do port forwarding in router-1 to enable it accesses internet. Access router setting interface through computer-1, for different router it has different setting interface. Therefore, the way to do port forwarding may be some different, please refer to the manual of the router. To most routers, we can find “virtual server” or forwarding rules page, input the camera-1’s LAN IP address and port then enable it. For example as below picture:

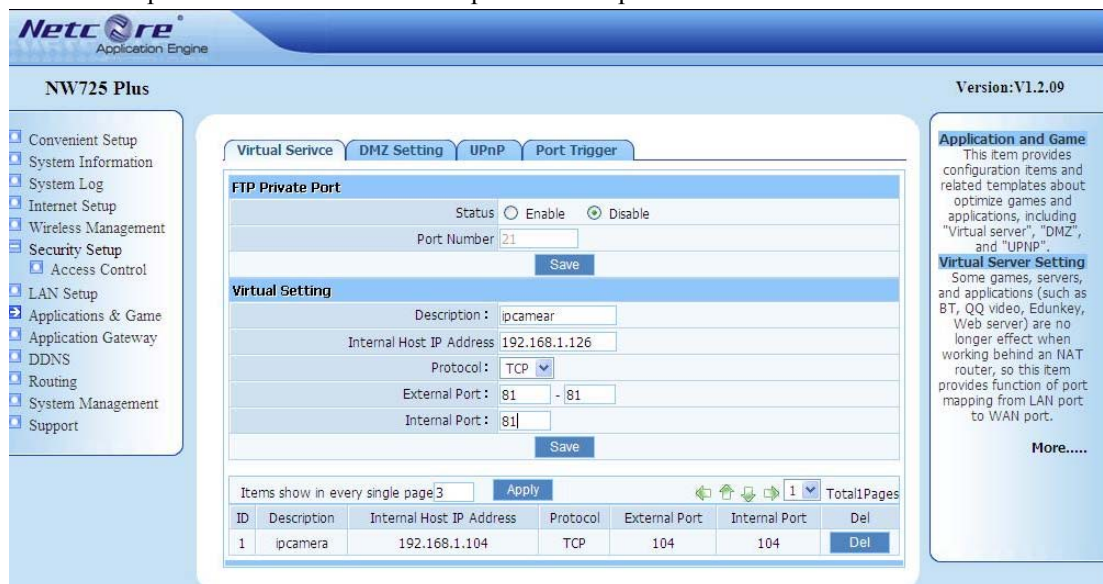

Note: for more cameras accessing internet, we need to do port forwarding for each camera, and we should set different ip and port to each camera to avoid confusion. If the port is not 80, and for inner(local area network) access, the link format should be IP address added colon and port, for example:<http://219.134.170.92:81>

8 Appendix

8.1 Common issue

❖ Forgot account?

Press reset button (on the bottom of device) on powered condition about 10 seconds to reset to factory settings..

Default administrator user: admin

Default password: admin

❖ The image is white.



Please adjust video parameters for camera (mode, brightness, contrast, saturation, etc) .

Resolution:	640*480	▼
Mode:	50 HZ	▼
Brightness:	6	▼
Contrast:	1	▼

If the background light is too strong, please adjust the range to view.

❖ **The camera finder can not find device.**

Please check if the camera and computer are in the same subnet. And if the cable or power adapter is not good, it will cause the problem too. **【Normally, the power light (yellow) is always on, the network light (green) is always flickering】** .

If it is the firewall limiting the access of camera finder.

❖ **The remote access does not work.**

- 1) If device works on LAN? If it can, then confirm the ddns if it is correct;
- 2) To check port forwarding in router if it is correct;
- 3) Does the network provided by ISP (network runner) can support to set up virtual server?

8.2 Warranty instruction

- a) Warranty for one year dues to this warranty card (not include man-made damage) . Late for warranty time, need to pay fee for service.
- b) If damage is caused by non-correct use or other reason not included in warranty, it can enjoy free repairing on warranty card except component fee.
- c) Send product with warranty card to manufacturer or seller when searching for repairing.
- d) Open shell and tear sealing label is not in warranty.
- e) It would not accept damaged device caused by transform or extra-adding.

Below cases are not in warranty

- a) The periodic inspection, maintenance, repair or replacement parts caused by normal wear and tear.
- b) Damage caused by fall, extrusion, artificial flooding, moisture and other man-made caused damage.
- c) Damage caused by flood, fire, lighting and other natural disasters or force majeure factors.
- d) Device ever repaired by non-authority.

List above refers to relevant provision if there is some change.



8.3 Warranty card

Please cut the below form for information and return with device

Product model		
Manufacture date		
Client agency		
User name		
User address		
Contact (TEL/mobile phone)		
maintain time	Problem details	result
note:		

Please cut along the dotted line